

1. Features

1. Accord with standard DMX512 protocol.
2. Output DMX512 signal and wireless 2.4G signal; More flexible application.
3. Support 4 channels control.
4. Support multi DMX512 master to control same decoder (Note: need same type DMX512 master).
5. Button with sound and LED indicating lamp.
6. This products can be controlled by Mi-Light/Miboxer RF remote, and smartphone (need WL-Box1 WiFi gateway).
7. This product can be used as RF remote to control Miboxer 2.4GHz lamps.

2. Parameters

Model No.: X1
 Input Voltage: AC100~240V 50/60Hz
 Output: DMX512+2.4G Wireless
 RF Transmitting Power: 6dBm
 RF Control Distance: 30m
 Working Temp.: -20~60°C

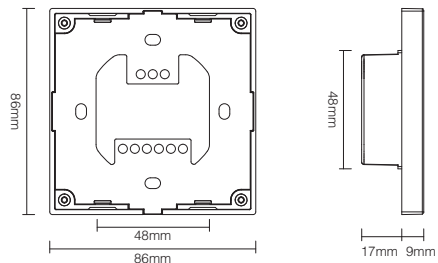

DMX512 Master (Single Color)
Model No.: X1

3. Connection Diagram

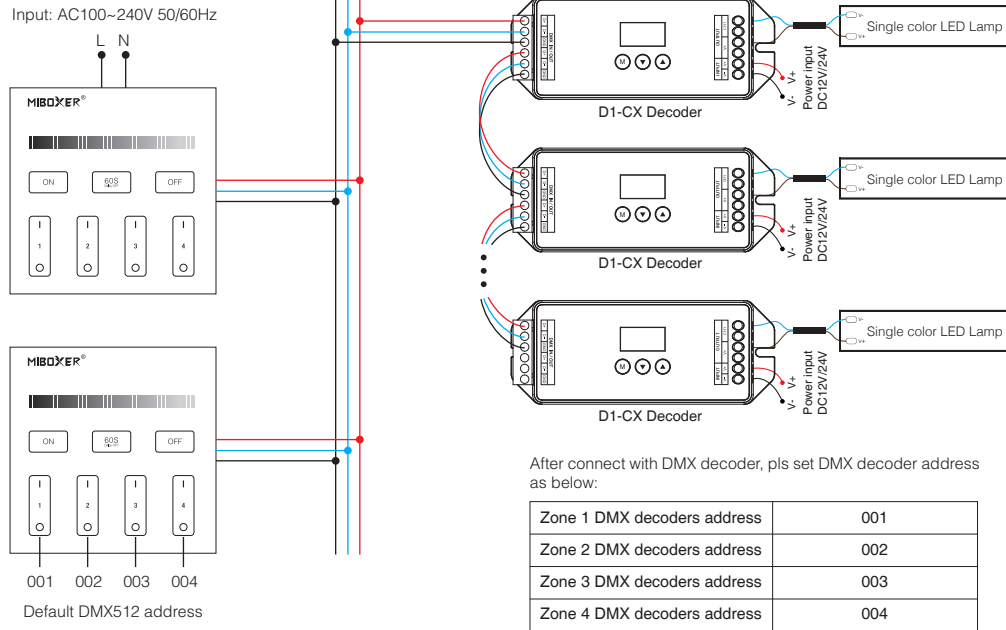

4. Function of keys

Remark: When touching the button, LED indicating lamp will flash once with different sound (Touch slider with no sound).

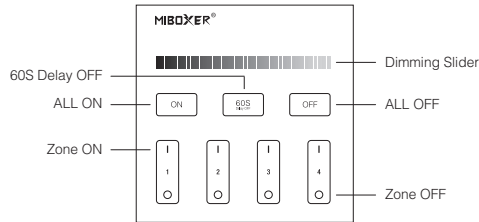

Touch dimming slider to change the brightness from 1~100%.

ON Touch master ON, turn on all linked lights.
Long press 5 seconds to turn ON the indicating sound.

60S When the light is ON, press "60S Delay OFF", the light will be OFF automatically after 60 seconds.

OFF Touch master OFF, turn off all linked lights.
Long press 5 seconds to turn OFF the indicating sound.

| Touch Zone ON, turn on zone-linked lights.

○ Touch Zone OFF, turn off zone-linked lights.

5. DMX512 master as RF remote Instruction

When using as a remote, you have to link to Miboxer 2.4GHz series lamps, then you can control the lamps.

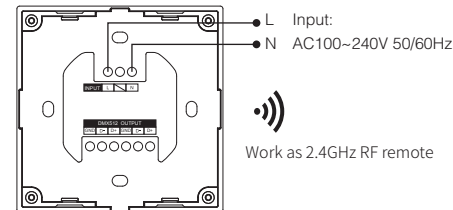

Linking Instructions

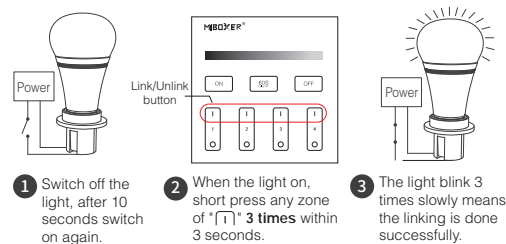

If the light not blink slowly, the linking failed, pls switch off the light again, and follow the above steps again.

Unlinking Instructions

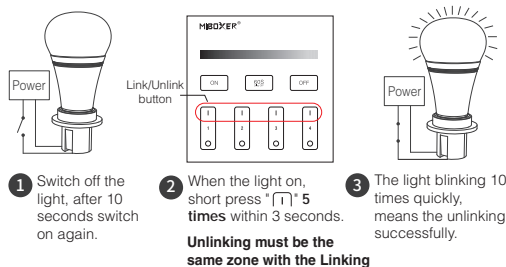

If the light not blink quickly, the unlink failed, pls switch off the light again, and follow the above steps to unlink again.

6. DMX512 master used as RF receiver Instruction

DMX512 master can receive RF remote signal, and transform it to DMX control signal to control the lamps.

Note: When RF remote control DMX512 master, RF remote need to link the master; after linking, RF remote 1-4 channel correspond to DMX512 master 1-4 channels.

Linking Instruction:

1. Long press 4th channel "1" button 5 seconds until DMX512 master indicating lamp blinking quickly.

2. Short press any channel "1" one time, when linking successfully, DMX512 master indicating lamp will blink 3 times slowly.

Unlink Instruction:

Long press DMX512 master 4th channel "1" button 5 seconds until DMX512 master indicating lamp blinking 10 times fast. that means unlinking successfully.

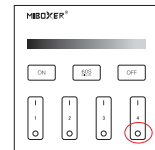
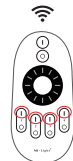
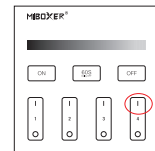

Compatible with these remote controls (Purchased separately)

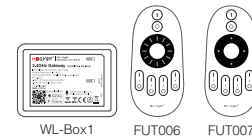

7. Installation/ Dismantlement

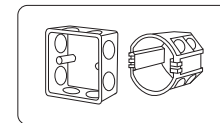

Install the bottom case into the wall; Above are the standard bottom cases.

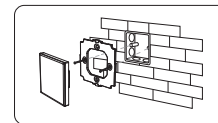

Fix the controller base on the bottom case with screw.

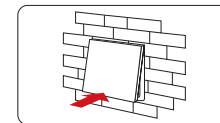

Clicks into the upper side of glass panel on the controller base, then press the lower side slightly to make it clicks into the controller base.

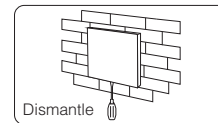

Plug into the below bayonet with a screwdriver, and upwarp screwdriver, then you can dismantle the controller.

8. Attention

1. The product shall be debugged and installed by professionals. During installation, ensure that the power is cut off to avoid the electric shock by wrong operation.
2. Please check whether the input voltage meets the product voltage requirements.
3. Before switching on the power, please ensure that all wiring is correct, so as not to cause damage to the DMX512 master.
4. If there is faults, non-professional please do not repair without permission, otherwise the device may be damaged.



Made in China